

Article number: 0128015

Description: Circlip RW 5 DIN 7993

Measures

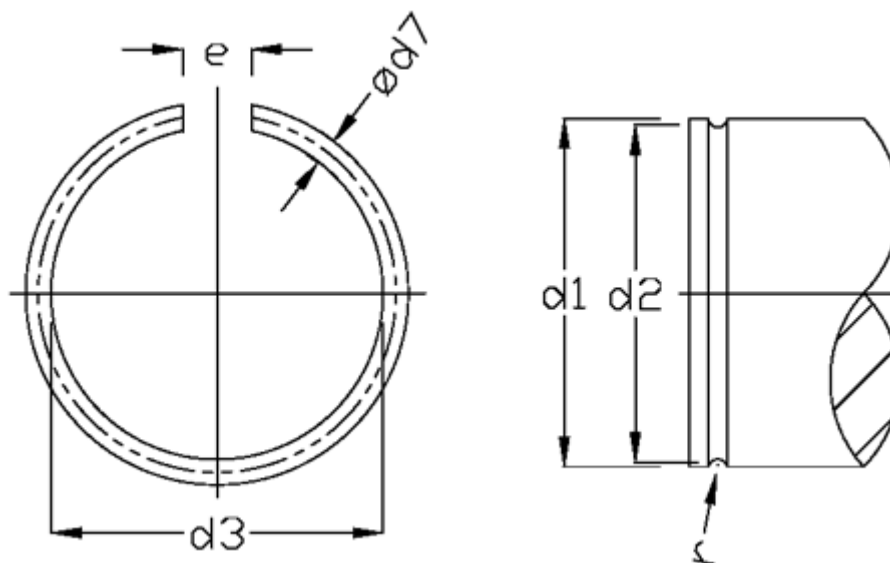

d1	= 5	tol	= 0.05
d2	= 4.2	tol	= -0.2
d3	= 4.1	Weight kg/1000 = 0.057	
d7	= 0.8		
Description	= RW 5		
e	= 1		
n abl x 1000	= 112		
r	= 0.5		